

1251B Plug-in Intelligent Ionization Sensor with Communications

3825 Ohio Avenue, St. Charles, Illinois 60174
 1-800-SENSOR2, FAX: 630-377-6495
 www.systemsensor.com

SPECIFICATIONS

Operating Voltage Range:	15 to 32 VDC
Maximum Average Standby Current:	300µA @ 24 VDC (one communication every 5 seconds with LED blink enabled)
Maximum Alarm Current (LED on):	6.5 mA @ 24 VDC
Operating Humidity Range:	10% to 93% Relative Humidity, Non-condensing
Operating Temperature Range:	32°F to 120°F (0°C to 49°C)
Height:	2.0" (51 mm) installed in B210LP Base
Diameter:	6.1" (155 mm) installed in B210LP Base; 4.1" (104 mm) installed in B501 Base
Weight:	5.4 oz. (153 g)

BEFORE INSTALLING

This sensor must be installed in compliance with the control panel system installation manual. The installation must meet the requirements of the Authority Having Jurisdiction (AHJ). Sensors offer maximum performance when installed in compliance with the National Fire Protection Association (NFPA); see NFPA 72.

GENERAL DESCRIPTION

Model 1251B intelligent ionization sensor uses a state-of-the-art sensing chamber. These sensors are designed to provide open area protection and are intended for use with compatible control panels only.

Two LEDs on each sensor light to provide a local, visible sensor indication. Remote LED annunciator capability is also available as an optional accessory (RA400Z/RA100Z).

The 1251B requires compatible addressable communications to function properly. Connect this sensor to listed-compatible control panels only.

SPACING

System Sensor recommends spacing sensors in compliance with NFPA 72. In low air flow applications with smooth ceilings, space sensors 30 feet apart. For specific information regarding sensor spacing, placement, and special applications, refer to NFPA 72 or the *System Smoke Detector Application Guide*, available from System Sensor.

WIRING GUIDE

All wiring must be installed in compliance with the National Electrical Code, applicable local codes, and any special requirements of the Authority Having Jurisdiction. Proper wire gauges should be used. The installation wires should be color-coded to limit wiring mistakes and ease system troubleshooting. Improper connections will prevent a system from responding properly in the event of a fire.

Remove power from the communication line before installing sensors.

1. Wire the sensor base (supplied separately) per the wiring diagram, see Figure 1.
2. Set the desired address on the sensor address switches, see Figure 2.
3. Install the sensor into the sensor base. Push the sensor into the base while turning it clockwise to secure it in place.
4. After all sensors have been installed, apply power to the control unit and activate the communication line.
5. Test the sensor(s) as described in the TESTING section of this manual.



Dust covers provide limited protection against airborne dust particles during shipping. Dust covers must be removed before the sensors can sense smoke. Remove sensors prior to heavy remodeling or construction.

FIGURE 1. WIRING DIAGRAM:

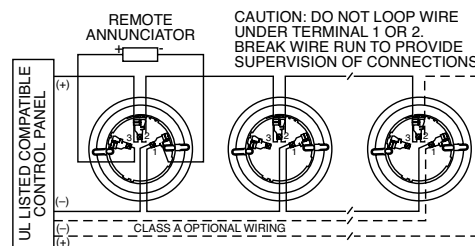

C0129-00

FIGURE 2. ROTARY DECADE ADDRESS SWITCHES:

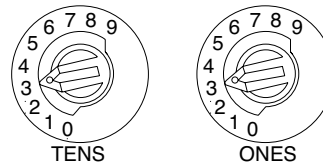

C0146-00

TAMPER-RESISTANCE

Model 1251B includes a tamper-resistant capability that prevents their removal from the bracket without the use of a tool. Refer to the base manual for details on making use of this capability.

TESTING

Before testing, notify the proper authorities that the system is undergoing maintenance, and will temporarily be out of service. Disable the system to prevent unwanted alarms.

All sensors must be tested after installation and periodically thereafter. Testing methods must satisfy the Authority Having Jurisdiction (AHJ). Sensors offer maximum performance when tested and maintained in compliance with NFPA 72.

Test the sensors as follows:

A. Functional: Magnet Test (P/N M02-04-01 or M02-09-00)

This sensor can be functionally tested with a test magnet. The test magnet electronically simulates smoke in the sensing chamber, testing the sensor electronics and connections to the control panel.

1. Hold the test magnet in the magnet test area as shown in Figure 3.
2. The sensor should alarm the panel.

Two LEDs on the sensor are controlled by the panel to indicate sensor status. Coded signals, transmitted from the panel, can cause the LEDs to blink, latch on, or latch off. Refer to the control panel technical documentation for sensor LED status operation and expected delay to alarm.

B. Smoke Entry

The GEMINI model 501 aerosol generator can be used for smoke entry testing. Set the generator to represent 4%/ft to 5%/ft obscuration as described in the GEMINI 501 manual. Using the bowl shaped applicator, apply aerosol until the panel alarms.

Additionally, canned aerosol simulated smoke (canned smoke agent) may be used for smoke entry testing of the smoke detector. Tested and approved aerosol smoke products are:

MANUFACTURER	MODEL
Home Safeguard Industries	25S
SDi	SMOKESABRE-01

When used properly, the canned smoke agent will cause the smoke detector to go into alarm. Refer to the manufacturer's published instructions for proper use of the canned smoke agent.

CAUTION

Canned aerosol simulated smoke (canned smoke agent) formulas will vary by manufacturer. Misuse or overuse of these products may have long term adverse effects on the smoke detector. Consult the canned smoke agent manufacturer's published instructions for any further warnings or caution statements.

A sensor that fails any of these tests should be cleaned as described under CLEANING, and retested. If the sensor fails after cleaning, it must be replaced.

When testing is complete, restore the system to the normal operation and notify the proper authorities that the system is back in operation.

FIGURE 3. TEST MAGNET POSITIONING:

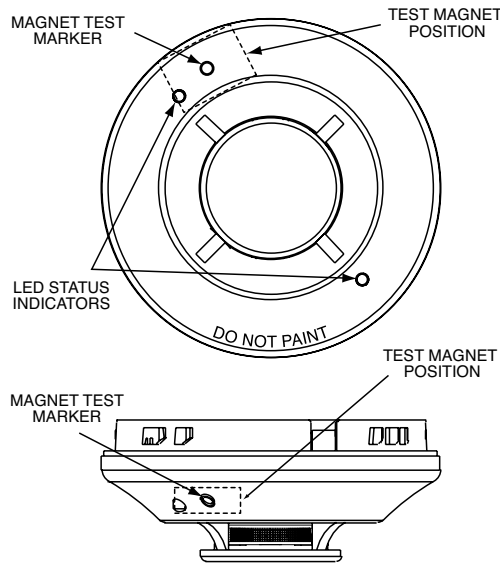

C0145-04

CLEANING

Before cleaning, notify the proper authorities that the system is undergoing maintenance and will be temporarily out of service. Disable the system to prevent unwanted alarms.

1. Remove the sensor to be cleaned from the system.
2. Remove the sensor cover. Press firmly on each of the four removal tabs that hold the cover in place.
3. Vacuum the outside of the screen carefully. If further cleaning is required, continue with Step 4, otherwise skip to Step 5.
4. Use clean, compressed air to remove dust and debris from the sensing chamber.
5. Replace the cover using the LEDs to align the cover and then gently pushing it until it locks into place.
6. Reinstall the detector.
7. Test the detector as described in TESTING.
8. Reconnect disabled circuits.
9. Notify the proper authorities that the system is back on line.

SPECIAL NOTE REGARDING SMOKE DETECTOR GUARDS

Smoke detectors are not to be used with detector guards unless the combination has been evaluated and found suitable for that purpose.

FIGURE 4:

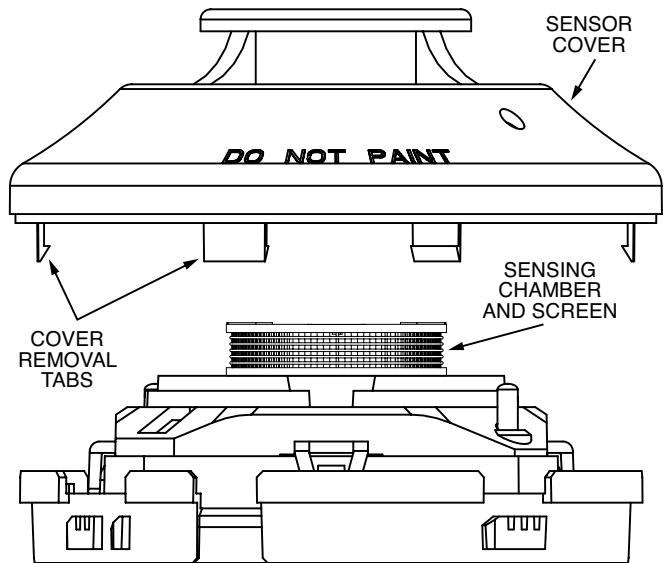

C0150-01

Please refer to insert for the Limitations of Fire Alarm Systems

THREE-YEAR LIMITED WARRANTY

System Sensor warrants its enclosed smoke detector to be free from defects in materials and workmanship under normal use and service for a period of three years from date of manufacture. System Sensor makes no other express warranty for this smoke detector. No agent, representative, dealer, or employee of the Company has the authority to increase or alter the obligations or limitations of this Warranty. The Company's obligation of this Warranty shall be limited to the repair or replacement of any part of the smoke detector which is found to be defective in materials or workmanship under normal use and service during the three year period commencing with the date of manufacture. After phoning System Sensor's toll free number 800-SENSOR2 (736-7672) for a Return Authorization number, send defective units postage prepaid to: System Sensor, Returns

Department, RA # _____, 3825 Ohio Avenue, St. Charles, IL 60174. Please include a note describing the malfunction and suspected cause of failure. The Company shall not be obligated to repair or replace units which are found to be defective because of damage, unreasonable use, modifications, or alterations occurring after the date of manufacture. In no case shall the Company be liable for any consequential or incidental damages for breach of this or any other Warranty, expressed or implied whatsoever, even if the loss or damage is caused by the Company's negligence or fault. Some states do not allow the exclusion or limitation of incidental or consequential damages, so the above limitation or exclusion may not apply to you. This Warranty gives you specific legal rights, and you may also have other rights which vary from state to state.

FCC STATEMENT

This device complies with part 15 of the FCC Rules. Operation is subject to the following two conditions: (1) This device may not cause harmful interference, and (2) this device must accept any interference received, including interference that may cause undesired operation.

NOTE: This equipment has been tested and found to comply with the limits for a Class B digital device, pursuant to Part 15 of the FCC Rules. These limits are designed to provide reasonable protection against harmful interference in a residential installation. This equipment generates, uses and can radiate radio frequency energy and, if not installed and used in accordance with the instructions, may cause harmful interference to radio communications. However, there is no guarantee that interference will not occur in a particular installation. If this equipment does cause harmful interference to radio or television reception, which can be determined by turning the equipment off and on, the user is encouraged to try to correct the interference by one or more of the following measures:

- Reorient or relocate the receiving antenna.
- Increase the separation between the equipment and receiver.
- Connect the equipment into an outlet on a circuit different from that to which the receiver is connected.
- Consult the dealer or an experienced radio/TV technician for help.